

Modeling of Butt Joint Composed of Nb₃Sn Cable-In-Conduit Conductors^{*})

Tetsuhiro OBANA, Kazuya TAKAHATA, Shinji HAMAGUCHI, Kyohei NATSUME, Shinsaku IMAGAWA, Toshiyuki MITO, Kaname KIZU¹⁾, Haruyuki MURAKAMI¹⁾ and Kiyoshi YOSHIDA¹⁾

National Institute for Fusion Science, Toki 509-5292, Japan

¹⁾*Japan Atomic Energy Agency, Naka 311-0193, Japan*

(Received 15 November 2013 / Accepted 10 June 2014)

To evaluate butt joint fabrication technology of Nb₃Sn cable-in-conduit (CIC) conductors, joint resistance and quench current were measured using a joint sample developed for the JT-60SA central solenoid (CS) coil. The measurements indicate that the butt joint fulfilled the design requirements. To simulate the butt joint characteristics, a one-dimensional numerical model simplifying the butt joint configuration was developed. Using the model, joint resistance and quench current of the butt joint were calculated. The calculations were in good agreement with the measurements. As a result, the model is valid for butt joint simulations.

© 2014 The Japan Society of Plasma Science and Nuclear Fusion Research

Keywords: JT-60SA, butt joint, Nb₃Sn, cable-in-conduit conductor, joint resistance, quench current

DOI: 10.1585/pfr.9.3405122

1. Introduction

In superconducting fusion magnets, many joints exist between superconducting conductors. Therefore, the performance of joints has a significant impact on fusion magnets. A butt joint is one of the joint types used in the magnets. The butt joint is suitable for situations where conductors are joined in a narrow space. The butt joint is very attractive for central solenoid (CS) coils of tokamak machines because it allows embedding of the joint into a winding pack that provides maximum magnetic flux at a given peak field in the winding [1]. The butt joint was adopted for JT-60 Super Advanced (JT-60SA) CS coils composed of Nb₃Sn cable-in-conduit (CIC) conductors [1, 2].

To evaluate the fabrication technology of the joint used in the JT-60SA CS coil, joint resistance and quench current of the joint sample were measured at the National Institute for Fusion Science (NIFS) test facility [3, 4]. In addition, numerical calculations of the butt joint were conducted using a model simplifying the butt joint configuration to simulate the measurements. In this study, the butt joint measurements are described. The calculation results are compared with the measurements. The modeling of the butt joint is also discussed.

2. Joint Sample

The joint sample is composed of Nb₃Sn CIC conductors [1,2] used in the JT-60SA CS coil. The conductor con-

Table 1 Specifications of the CS coil conductor.

Number of Nb ₃ Sn Strands	216
Number of Cu wires	108
Local void fraction (%)	34
Cable dimensions (mm)	Dia. 21.8
Central spiral (id × od) (mm)	7 × 9
Conductor external dimensions (mm)	27.9 × 27.9
Cabling pattern	3 × 3 × 6 × 6
Twist pitch sequence (mm)	45/85/125/160

sists of 216 Nb₃Sn strands plated with chromium and 108 copper wires. The conductor is equipped with a central spiral made of SUS316L. Subwrapped tapes are not utilized. The conductor conduit is composed of SUS316LN. Specifications of the conductor are listed in Table 1.

The joint sample is illustrated in Fig. 1. The sample is hairpin shaped and consists of two butt joints. The sample has a single inlet and double outlets for supercritical helium (SHe). The total length of the sample is 1,835 mm. A case made of SUS316 is used to make the sample hairpin curve instead of the conduit. At the termination, a Nb₃Sn cable is connected to an oxygen-free copper plate by sinter bonding.

Figure 2 shows the configuration and photograph of the butt joint without the conduit. The cross-section of the butt joint with the conduit is illustrated in Fig. 3. In butt joint production, the conduit is removed to expose the Nb₃Sn cable before heat treatment of the Nb₃Sn strands. The central spiral is replaced with a cone-shaped flow distributor. The cables are compacted to 2% void fraction using copper sleeves. After the heat treatment, joining sur-

author's e-mail: obana.tetsuhiro@LHD.nifs.ac.jp

^{*}) This article is based on the presentation at the 23rd International Toki Conference (ITC23).

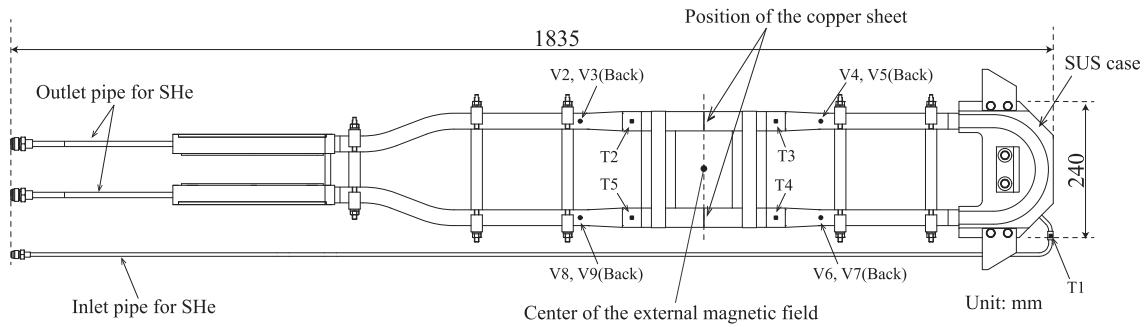

Fig. 1 Schematic view of the joint sample. V2-V9 and T1-T5 indicate the position of the voltage taps and thermometer, respectively.

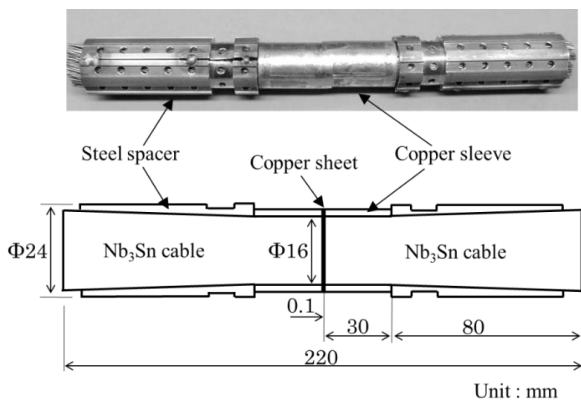

Fig. 2 Photograph and configuration of the butt joint without conduit.

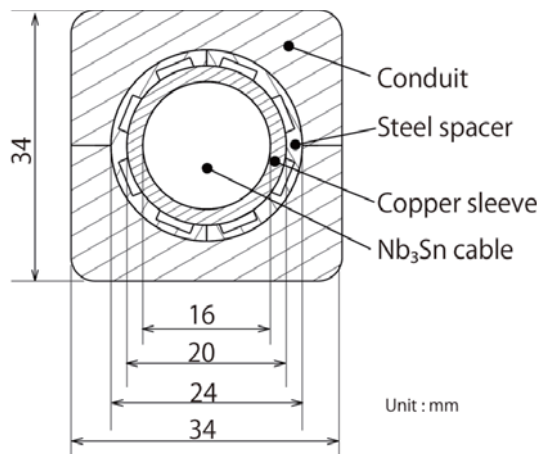

Fig. 3 Cross-section of the joint sample at the butt joint.

faces of the cables are cut and polished. Subsequently, 0.1-mm-thick copper sheet is inserted in the surfaces. The joining part is heated for diffusion bonding in vacuum. The conduit and spacers are then assembled. Details of the butt joint are described in Ref. [2].

3. Measurements

Joint resistances of the joint sample were measured at the NIFS test facility [3, 4]. As illustrated in Fig. 1, the

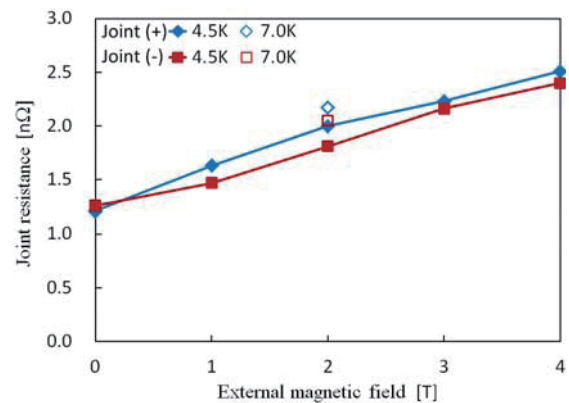

Fig. 4 Joint resistance of the joint samples.

sample was equipped with thermometers and voltage taps attached to the conduit. To accurately measure the joint resistance, two pairs of voltage taps were utilized for the butt joint. The pairs V2-V5 and V3-V4 were used for joint (-) and the pairs V6-V9 and V7-V8 were used for joint (+). For the measurement, SHe temperature was controlled using a film heater and thermometer (T1) attached to the inlet pipe.

Figure 4 shows the measurement results of joint resistance. The measurements indicated that the performance of the butt joint fulfilled the design requirement in which the joint resistance was less than 5 nΩ at 2 T [2, 5]. In addition, to investigate stable operating conditions of the butt joint, a stability test was performed using the joint sample. In this test, the quench current was measured under several conditions. The measurements indicated that the butt joint has a temperature margin of 4 K for real operating conditions as follows: transport current, 20 kA; external magnetic field, 2 T; operating temperature, 7 K [5].

4. Modeling

4.1 Numerical model of the butt joint

Regarding joint resistance and quench current of the butt joint, one-dimensional numerical calculations were conducted with a numerical model simplifying the butt joint configuration. Using a symmetrical configuration of the butt joint at the center of the joint, the configuration of

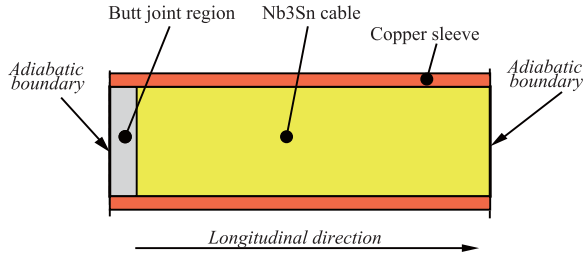

Fig. 5 Schematic view of the numerical model simplifying half of the butt joint.

the numerical model was simplified, as illustrated in Fig. 5. The model is composed of the butt joint region, Nb₃Sn cable, and copper sleeve. In the model, the Nb₃Sn cable is combined with 216 Nb₃Sn strands and 108 copper wires, which represent the cable compacted to 2% void fraction. The butt joint region is composed of oxygen-free copper. The thickness of the copper, which is 1.6 mm, was derived from the measured joint resistance of the butt joint at 4.5 K without a magnetic field. Therefore, the butt joint region represents not only the electrical resistance of the copper sheet but also the contact resistance between the Nb₃Sn cable and copper sheet. The boundary of the model in the longitudinal direction is defined as an adiabatic condition. The temperature of the copper sleeve is constant.

4.2 Equations

To investigate the quench current of the butt joint, a one-dimensional thermal equilibrium equation including a joule heating term and a cooling term was solved using a difference method. The equation is given by

$$\gamma \cdot c_p \cdot \frac{\partial T}{\partial t} = \frac{\partial}{\partial x} \left(\lambda \frac{\partial T}{\partial x} \right) + g - \frac{h_c}{A} \cdot (T - T_b), \quad (1)$$

where γ is the density, c_p is the specific heat at constant pressure, T is the temperature, T_b is the base temperature (which is the copper sleeve's temperature), t is the time, x is the longitudinal length, λ is the thermal conductivity in the longitudinal direction, g is the joule heat generation, h_c is the thermal conductivity between the cable and copper sleeve per unit length, and A is the cable cross-section. In the calculations, h_c is used as a fitting parameter.

In the butt joint region of the model, the joule heating term is given by

$$g = \rho \cdot \left(\frac{I_t}{A} \right)^2, \quad (2)$$

where ρ is the electrical resistivity of copper and I_t is the transport current. In the Nb₃Sn cable, the joule heating term is given by

$$\begin{aligned} g &= 0 \quad (T \leq T_{cs}), \\ g &= \rho \cdot \left(\frac{I_t}{A} \right)^2 \left(\frac{T - T_{cs}}{T_c - T_{cs}} \right) \quad (T_{cs} \leq T \leq T_c), \text{ and} \quad (3) \\ g &= \rho \cdot \left(\frac{I_t}{A} \right)^2 \quad (T_c \leq T), \end{aligned}$$

where T_{cs} is the current sharing temperature and T_c is the critical temperature [6]. The current sharing temperature is given by

$$T_{cs} = T_c - \frac{I_t}{n \cdot I_c(T, B, \varepsilon)} (T_c - T_b), \quad (4)$$

where n is the number of Nb₃Sn strands, $I_c(T, B, \varepsilon)$ is the critical current at the base temperature, B is the magnetic field, and ε is the strain generated in the Nb₃Sn strand. $I_c(T, B, \varepsilon)$ was derived from Ref. [7,8]. In this model, ε is assumed to be -0.73% [9]. The magnetic field B , accounting for self and external magnetic fields, is defined by

$$B = B_{\text{ext.}} + 0.5 \times \frac{I_t}{2.0 \times 10^4}, \quad (5)$$

where $B_{\text{ext.}}$ is an external magnetic field. In the calculations, the magnetic field is uniform along the longitudinal direction.

5. Calculation Results

5.1 Joint resistance

Joint resistance of the butt joint was calculated using the model. For the calculations, following parameters were used. I_t was 20 kA, T_b was 4.5 K, and h_c was 4 W/(m·K). Figure 6 shows the results of the measurements and calculations under various external magnetic fields. The calculations fairly agree with the measurements at each magnetic field.

5.2 Quench current

The quench current of the butt joint was calculated under a variety of conditions. For the calculations, h_c was 4 W/(m·K). Figure 7 shows the comparison between measurements and calculations with regard to the quench current. In the measurements, the mass flow rate of SHe was maintained at 3 g/s. In Fig. 7, temperatures of the calculations and measurements are indicative of those of copper sleeve and conduit, respectively. Both the temperatures were assumed to be same. As a result, the calculation is in good agreement with the measurement.

6. Discussion

In the measurement, although the voltage of the pair V2-V5 agreed with that of the pair V3-V4, there was voltage difference between the pair V6-V9 and the pair V7-V8, which were used for joint (+). Current distribution at the joint (+) might be non-uniform. In the evaluation of joint resistance, the slope of the current-voltage curve was used. As a result, the joint resistances obtained by the pairs V6-V9 and V7-V8 were consistent.

As described in Section 2, the Nb₃Sn cable was compacted to 2% void fraction. The thermal conductivity in the radial direction of the cable is largely improved compared with the Nb₃Sn cable covered with a conduit. The temperature gradient of the cable in the radial direction will be

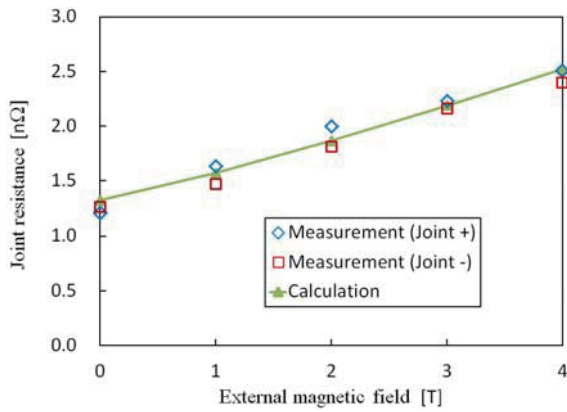

Fig. 6 Comparison between measurement and calculation with regard to joint resistance at 4.5 K.

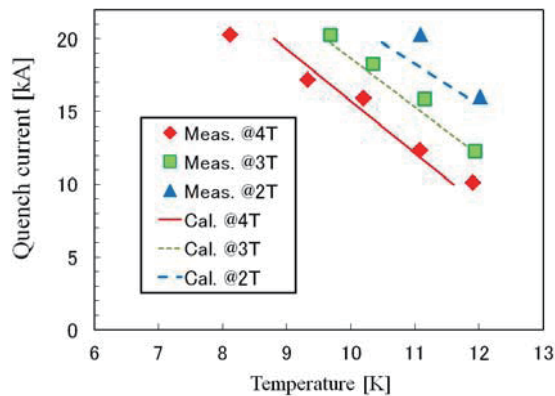

Fig. 7 Comparison between measurement and calculation with regard to quench current.

small at the butt joint. Therefore, a one-dimensional model in the longitudinal direction will be valid to simulate the butt joint characteristics.

In Fig. 7, there is a slight discrepancy between the measurement and calculation. As a cause of the discrepancy, h_c is considered. In the model, h_c was used to be fixed. Hence it cannot deal with a variety of heating and

cooling conditions of the butt joint. To minimize the discrepancy, the improvement of h_c is necessary as a future plan.

7. Conclusion

The joint resistance and quench current of the butt joint composed of Nb₃Sn strands were measured using a joint sample for JT-60SA CS coils. The measurements indicated that the butt joint fulfills the design requirement.

Numerical calculations were conducted with a one-dimensional numerical model simplifying the butt joint configuration. Regarding joint resistance and quench current of the butt joint, the calculations are in good agreement with the measurements. As a result, the proposed model is validated to simulate the characteristics of the butt joint.

Acknowledgments

The authors would like to thank Dr. Chikaraishi of NIFS, Mr. K. Ueda of Taiyo Nippon Sanso Co. Ltd., and the operating staff of Hitachi Co. Ltd. for their technical support.

- [1] K. Yoshida, K. Tsuchiya, K. Kizu *et al.*, *Physica C* **470** (20), 1727 (2010).
- [2] K. Kizu, H. Murakami, K. Tsuchiya *et al.*, *IEEE Trans. Appl. Supercond.* **23** (3), 4200104 (2013).
- [3] T. Obana, K. Takahata, S. Hamaguchi *et al.*, *Fusion Eng. Des.* **84**, 1442 (2009).
- [4] J. Yamamoto, T. Mito, K. Takahata *et al.*, *Fusion Eng. Des.* **20**, 147 (1993).
- [5] H. Murakami, K. Kizu, K. Tsuchiya *et al.*, *Abstracts of CSJ Conference* **87**, 40 (2013).
- [6] Y. Iwasa, *Case Studies in Superconducting Magnets – Design and Operational Issues Second Edition* (Springer, 2009).
- [7] D. Talyer, D. Hampshire *et al.*, *Supercond. Sci. Technol.* **18**, S241 (2005).
- [8] Y. Nunoya, T. Isono, N. Koizumi *et al.*, *IEEE Trans. Appl. Supercond.* **18** (2), 1055 (2008).
- [9] H. Murakami, K. Kizu, T. Ichige *et al.*, *Proceedings of ICEC24-ICMC2012*, 575 (2013).