

# Isotope Effect on Charge Transfer Cross Sections of Slow ${}^7\text{Li}^+$ Ions in Collisions with $\text{H}_2$ , HD, and $\text{D}_2$ Molecules<sup>\*</sup>)

Toshio KUSAKABE, Hiroyuki TAWARA<sup>1)</sup> and Hiroyuki A. SAKAUE<sup>1)</sup>

*Kinki University, 3-4-1 Kowakae, Higashi-Osaka 577-8502, Japan*

<sup>1)</sup>*National Institute for Fusion Science, 322-6 Oroshi-cho, Toki 509-5292, Japan*

(Received 22 November 2012 / Accepted 2 April 2013)

Charge transfer cross sections of  ${}^7\text{Li}^+$  ions in collisions with  $\text{H}_2$ , HD, and  $\text{D}_2$  molecules have been measured in the energy range from 1.4 to 4.0 keV using the growth rate method. Significant differences in the charge transfer cross sections between collisions of  ${}^7\text{Li}^+$  ions with  $\text{H}_2$  and HD, and with  $\text{H}_2$  and  $\text{D}_2$  molecules, the so-called target isotope effect, are observed at collision energies from 1.4 to 2.4 keV. The observed charge transfer cross section ratios of  $\sigma(\text{HD})/\sigma(\text{H}_2)$  and  $\sigma(\text{D}_2)/\sigma(\text{H}_2)$  are found to be approximately 0.7 at 1.4 keV. They are gradually increasing, and finally approaching unity at energies above 2.4 keV.

© 2013 The Japan Society of Plasma Science and Nuclear Fusion Research

Keywords: singly charged lithium ion, hydrogen molecule, charge transfer cross section, isotope effect, growth rate method, plasma diagnostics

DOI: 10.1585/pfr.8.2401100

## 1. Introduction

Among many interactions and dynamical processes, the charge transfer process of slow  $\text{Li}^+$  ions in collisions with  $\text{H}_2$  molecules is one of the fundamental “ion-molecule” collisions. Since a valence electron (2s) of the ground-state lithium atom belonging to alkaline metals is far from the two electrons in the K shell (1s), the ionization potential of Li atoms is relatively small, i.e., 5.4 eV and singly charged lithium ions are easily produced.

Lithium atoms and ions are sometimes used for the purpose of plasma diagnostics in fusion devices. Therefore, cross-section data and any knowledge of collision dynamics for these charge transfer processes at low collision energies are known to be important and useful in controlled thermonuclear fusion research [1] as well as in a number of other applications.

However charge transfer cross section measurements of  $\text{Li}^+ + \text{H}_2$  collisions are sparse, particularly at low collision energies. To the best of our knowledge, Allison *et al.* [2], VanEck and Kistemaker [3], and Ogurtsov *et al.* [4] reported the cross section measurements below 50 keV. Furthermore, few studies, e.g., Elizaga *et al.* [5], treated theoretically the charge transfer process of slow  $\text{Li}^+$  ions colliding with  $\text{H}_2$  molecules.

On the other hand, we have previously investigated the isotope effect on charge transfer by slow hydrogen ions ( $\text{H}^+$  and  $\text{D}^+$  ions) from hydrogen molecules ( $\text{H}_2$ , HD, and  $\text{D}_2$ ) [6–8]. The charge transfer cross section ratios  $\sigma(\text{H}^+ + \text{D}_2)/\sigma(\text{H}^+ + \text{H}_2)$  and  $\sigma(\text{D}^+ + \text{D}_2)/\sigma(\text{H}^+ + \text{H}_2)$  decreased to a value smaller than unity below a collision energy of

1 keV/u, and reached a value of about 0.6 at 0.18 keV/u. Contrary to the cases of  $\text{H}_2$  and  $\text{D}_2$ , the experimental  $\sigma(\text{H}^+ + \text{HD})/\sigma(\text{H}^+ + \text{H}_2)$  and  $\sigma(\text{D}^+ + \text{HD})/\sigma(\text{H}^+ + \text{H}_2)$  ratios were found to be almost unity in the entire investigated energy region from 0.18 to 1.5 keV/u. Theoretical analyses based on the molecular-orbital close coupling method were applied to these collisions taking into account the difference of the vibrational energy of the product hydrogen molecular ions and the Franck-Condon principle.

To establish the cross section data and obtain more comprehensive understanding of the isotope effect on the charge transfer in ion-molecule collisions of the hydrogen family, therefore we have measured, in the present study, the charge transfer cross sections of  ${}^7\text{Li}^+$  ions colliding with  $\text{H}_2$ , HD, and  $\text{D}_2$  molecules in the energy range from 1.4 to 4.0 keV using the growth rate method.

## 2. Experimental Method

A detailed description of the experimental apparatus and methods employed in this study has been reported previously [6]. Only the essential features and different points are mentioned here.

As shown in Fig. 1, singly charged lithium ions were produced from a surface ionization ion source (SIIS) [9]. A  $2 \times 2 \times 0.03 \text{ mm}^3$  platinum foil spot-welded to a 0.15 mm diameter tungsten filament was used as the anode for a lithium ion emitter, which was coated with a mixed powder of  $\text{Li}_2\text{CO}_3$ ,  $\text{Al}_2\text{O}_3$ , and  $\text{SiO}_2$ . The extracted lithium ion beam was analyzed according to its energy, charge, and mass with a Wien filter using two ferrite permanent magnets. A typical mass spectrum for lithium atoms is shown in Fig. 2. Pure  ${}^7\text{Li}^+$  ions were separately obtained with natural isotope  ${}^6\text{Li}^+$  ions. In the present study,  ${}^7\text{Li}^+$  ions were

author's e-mail: kusakabe@phys.kindai.ac.jp

<sup>\*</sup>) This article is based on the presentation at the 22nd International Toki Conference (ITC22).

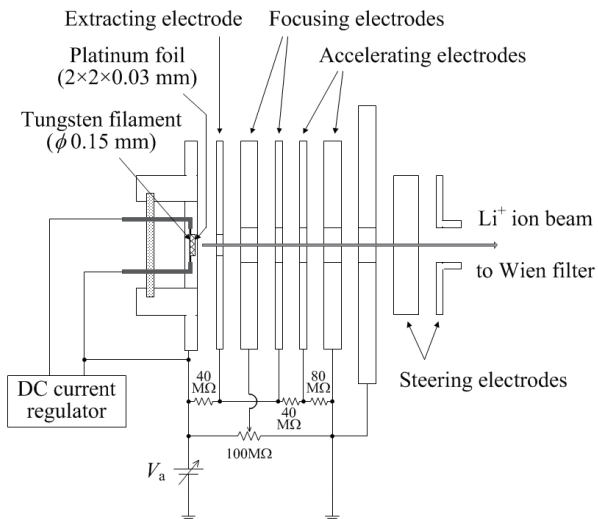

Fig. 1 Cross sectional view of the SIIS and electric circuit for ion extraction.

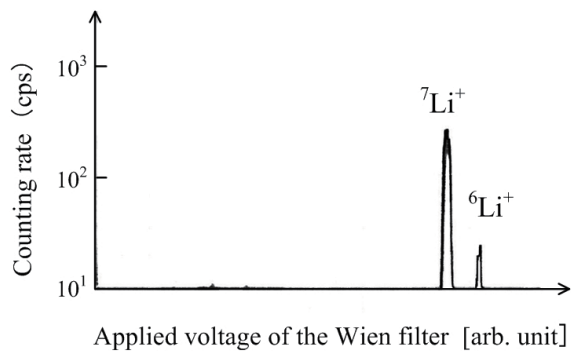

Fig. 2 Typical mass spectrum of lithium extracted from the SIIS. The ion accelerating voltage is 1.7 kV.

used for charge transfer cross section measurements.

After mass separation with the Wien filter, the  ${}^7\text{Li}^+$  ion beam was introduced into a 4-cm long collision cell in which target gases of high purity ( $\text{H}_2$  99.999%;  $\text{D}_2$  99.9%; HD 97.0%) were filled. The lithium ions and energetic neutral particles emerging from the cell after the collisions were charge-separated using electrostatic parallel plates and detected with a position-sensitive micro-channel plate detector (MCP-PSD). Charge transfer cross sections were derived based on the so-called growth rate method. Target gas pressure was directly measured in the present study with an MKS-Baratron capacitance manometer, and ranged from 0.1 to 2 Pa. Back pressure was less than about  $5 \times 10^{-6}$  Pa in the vacuum chambers, which were evacuated by 500 l/s and 50 l/s turbo-molecular pumps and a 6'' cryogenic pump.

The statistical uncertainties of the cross sections derived from the growth curves were less than 8.83% for the present work. Uncertainties due to target thickness, temperature of target gas, and so forth were estimated to be from 8.25% at high energies to 17.2% at low energies. To-

Table 1 Charge transfer cross section of  ${}^7\text{Li}^+$  ions colliding with  $\text{H}_2$ , HD, and  $\text{D}_2$  molecules.

| Energy (keV) | Cross section ( $\times 10^{-17} \text{ cm}^2$ ) |                 |                 |
|--------------|--|-----------------|-----------------|
|              | $\text{H}_2$                                     | HD              | $\text{D}_2$    |
| 1.4          | $1.29 \pm 0.18$                                  | $0.92 \pm 0.14$ | $0.89 \pm 0.13$ |
| 1.7          | $1.49 \pm 0.19$                                  | $1.18 \pm 0.17$ | $1.15 \pm 0.15$ |
| 2.0          | $1.62 \pm 0.17$                                  | $1.51 \pm 0.17$ | $1.39 \pm 0.15$ |
| 2.4          | $1.78 \pm 0.18$                                  | $1.92 \pm 0.21$ | $1.72 \pm 0.18$ |
| 3.0          | $2.10 \pm 0.19$                                  | $2.10 \pm 0.22$ | $2.01 \pm 0.18$ |
| 4.0          | $2.45 \pm 0.22$                                  | $2.45 \pm 0.25$ | $2.48 \pm 0.22$ |

tal experimental uncertainties of the absolute cross sections were given as the quadratic sum of these uncertainties involved.

### 3. Results and Discussion

The present experimental charge transfer cross sections of  ${}^7\text{Li}^+$  ions colliding with  $\text{H}_2$ , HD, and  $\text{D}_2$  molecules are listed in Table 1.

#### 3.1 $\text{H}_2$ molecules

The present experimental charge transfer cross sections of  ${}^7\text{Li}^+$  ions in collisions with  $\text{H}_2$  molecules are shown in Fig. 3 together with the earlier measurements of Allison *et al.* [2], VanEck and Kistemaker [3], and Ogurtsov *et al.* [4], and the theoretical calculations by Elizaga *et al.* [5].

Previous experimental data coincide only to each other at the narrow energy range of 10 to 20 keV, and the connection of these data is found to be unsatisfactory in the other energy region. The present experimental measurements increase monotonously with the collision energy, and are close to the data of VanEck and Kistemaker [3]. However the data of Ogurtsov *et al.* [4] are about 50% smaller than the present experimental results.

The specific processes we are concerned with are charge transfer from the ground electronic and vibrational states of target molecules, viz.,

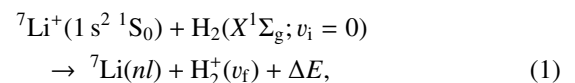

where  $v_i$  and  $v_f$  are the quantum numbers for the initial and final vibrational states, respectively, and  $n$  and  $l$  represent the final principal and angular quantum numbers of the lithium atom, respectively, and  $\Delta E$  is the energy defect. When  $n = 2$  and  $l = s$ , this process is largely endothermic and the large energy defect  $\Delta E$  is  $-10.0$  eV. This can qualitatively explain the smallness and energy dependence of the present observed cross section data.

The theoretical results for the total charge transfer cross sections to Li ( $1s^2 \ 2l$ ) reported by Elizaga *et al.* [5], based on a secondary sudden approximation are found

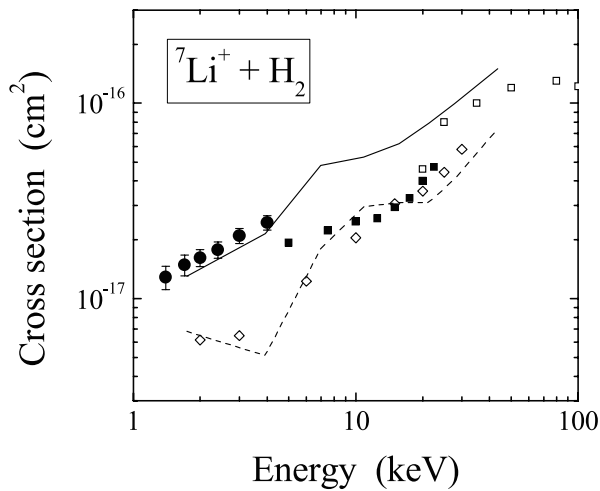

Fig. 3 Charge transfer cross sections of  ${}^7\text{Li}^+$  ions colliding with  $\text{H}_2$  molecules. Experimental data: ●, present data; □, Allison *et al.* [2]; ■, VanEck and Kistemaker [3]; ◇, Ogurtsov *et al.* [4]. Theoretical calculation: Elizaga *et al.* [5] (solid line, transfer to  $2l$ ; broken line, transfer to  $2s$ ).

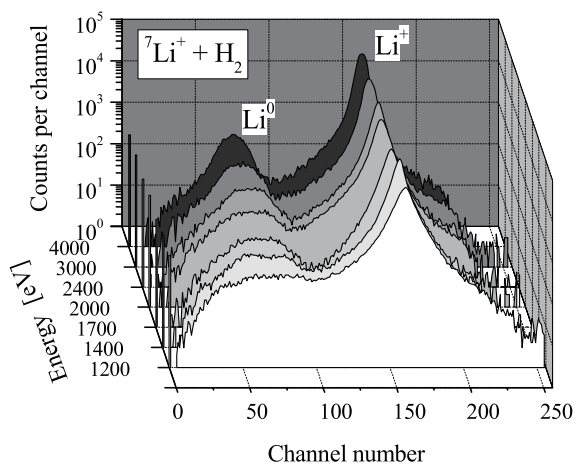

Fig. 4 Charge spectra of incident  $\text{Li}^+$  ions and charge-transferred  $\text{Li}^0$  atoms in  $\text{Li}^+ + \text{H}_2$  collisions. The pressure of target  $\text{H}_2$  gases was about 1 Pa.

to reasonably agree with the present experimental results. While their results for the partial charge transfer cross sections to  $\text{Li}$  ( $1s^2 2s$ ) are close to the data of Ogurtsov *et al.* [4] and of VanEck and Kistemaker [3].

We attempted to measure the charge transfer cross sections at energies below 1.2 keV. However, charge-transferred lithium atoms were found to be heavily scattered at large angles as pointed out by Ogurtsov *et al.* [4]. Therefore, a considerable portion of charge-transferred lithium atoms could not pass through the exit aperture of the collision cell, and the absolute cross sections of  $\text{Li}^+$  ions colliding with hydrogen molecules could not be determined at energies below 1.2 keV. In Fig. 4, the charge spectra of incident lithium ions and charge-transferred lithium

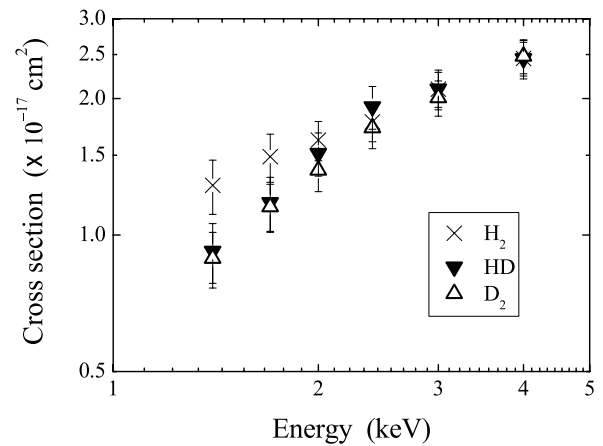

Fig. 5 Charge transfer cross sections of  ${}^7\text{Li}^+$  ions colliding with HD and  $\text{D}_2$  molecules. Experimental data: ×,  $\text{H}_2$  molecules; ▼, HD molecules; △,  $\text{D}_2$  molecules.

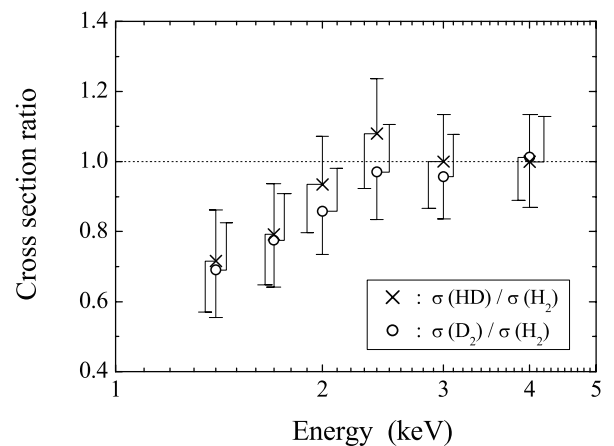

Fig. 6 Charge transfer cross section ratios of HD and  $\text{D}_2$  to  $\text{H}_2$  molecules. Experimental data: ×, HD molecules; ○,  $\text{D}_2$  molecules.

atoms, which were measured with the MCP-PSD and recorded in the memory of the pulse height analyzer, are shown. The peak width of the charge-transferred lithium atoms spreads with a decrease in the incident energy, and they do not form a significant peak at 1.2 keV.

### 3.2 HD and $\text{D}_2$ molecules

In Fig. 5, the present charge transfer cross sections of  ${}^7\text{Li}^+$  ions colliding with HD and  $\text{D}_2$  molecules are shown together with the present data for  $\text{H}_2$  molecules. Figure 6 shows the charge transfer cross section ratios of  ${}^7\text{Li}^+$  ions colliding with HD and  $\text{D}_2$  molecules, i.e.,  $\sigma(\text{HD})/\sigma(\text{H}_2)$  and  $\sigma(\text{D}_2)/\sigma(\text{H}_2)$ .

Both the present charge transfer cross sections of HD and  $\text{D}_2$  molecules are almost the same over the present investigated energy range and become gradually smaller with a decrease in incident energy than those of  $\text{H}_2$  molecules. The observed charge transfer cross section ratios of  $\sigma(\text{HD})/\sigma(\text{H}_2)$  and  $\sigma(\text{D}_2)/\sigma(\text{H}_2)$  become smaller

than unity below 2.4 keV, and reach a value of about 0.72 and 0.69, respectively, at 1.4 keV. It is noted that the peak profile of the lithium atoms after charge transfer was almost the same for each collision energy, regardless of target hydrogen molecule species.

In conclusion, marked characteristics in the charge transfer cross sections between collisions of  ${}^7\text{Li}^+$  ions with  $\text{H}_2$ , HD, and  $\text{D}_2$  molecules, the so-called target isotope effect, are observed at energies below 2.4 keV. It is understood that the isotope effect in the charge transfer of ion-molecule collisions originates from the combination of small offset in binding and vibrational energies and different spaces occupied by wave functions of the target  $\text{H}_2$ , HD, and  $\text{D}_2$  molecules. In  $\text{H}^+ + \text{HD}$  collisions, however, this target isotope effect was not experimentally observed [8]. At present, the cause of the difference in the isotope effect by incident ionic species is unknown. Further progress of both experimental and theoretical studies to clarify this reason is expected.

## Acknowledgments

The authors would like to express their sincere appreciation to Doctor Lukáš Pichl and the late Professor Mineo Kimura for their valuable discussions. The present study was performed as a collaboration research program of the National Institute for Fusion Science in Japan (NIFS04KQHM001).

- [1] R.K. Janev, *Atomic and Molecular Processes in Fusion Edge Plasmas* (Plenum, New York, 1995) p.1.
- [2] S.K. Allison *et al.*, *Phys. Rev.* **120**, 1266 (1960).
- [3] J. VanEck and J. Kistemaker, *Physica* **26**, 629 (1960).
- [4] G.N. Ogurtsov *et al.*, *Sov. Phys.-Tech. Phys.* **11**, 362 (1966).
- [5] D. Elizaga *et al.*, *J. Phys. B: At. Mol. Opt. Phys.* **33**, 2037 (2000).
- [6] T. Kusakabe *et al.*, *Phys. Rev. A* **62**, 062714 (2000).
- [7] T. Kusakabe *et al.*, *Phys. Rev. A* **68**, 050701(R) (2003).
- [8] T. Kusakabe *et al.*, *Phys. Rev. A* **70**, 052710 (2004).
- [9] T. Kusakabe *et al.*, *J. Sci. Technol. Kinki Univ.* **22**, 269 (1986) (in Japanese, unpublished).